



United Technologies
turn to the experts 



42HS Fan Coil Unit (High Static Pressure)

Air Volume: 1360~3400m³/h



Turn To The Experts

Founded by the inventor of modern air conditioning, Carrier is the world's leader in high-technology heating, air-conditioning and refrigeration solutions. Carrier experts provide sustainable solutions, integrating energy-efficient products, building controls and energy services for residential, commercial, retail, transport and food service customers. Carrier is a part of UTC Building & Industrial Systems, a unit of United Technologies Corp., a leading provider to the aerospace and building systems industries worldwide.

With a broad portfolio of advanced technical patent awards, our global R&D center in Shanghai develops innovative heat, ventilation and air-conditioning (HVAC) solutions.



In 1998, Time magazine named Dr. Carrier one of its 20 most influential builders and titans of the 20th century.



Model Number Nomenclature

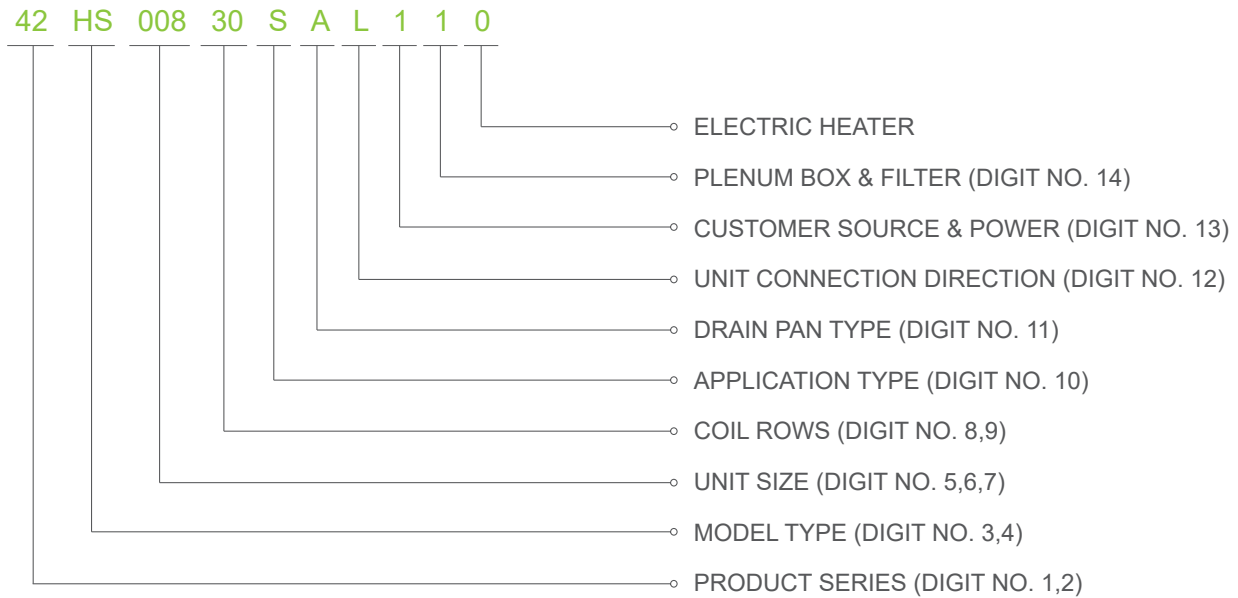

✔ DIGIT NO. 1,2
Product Series
42 : Fan Coil Unit

✔ DIGIT NO. 3,4
Model Type
HS : High Static Pressure Horizontal Ceiling FCU

✔ DIGIT NO. 5,6,7
Unit Size
008, 010, 012, 014, 016, 018, 020

✔ DIGIT NO. 8,9
Coil Rows
30 : 3 Rows Cooling
40 : 4 Rows Cooling
31 : 3 Rows Cooling + 1 Row Heating

✔ DIGIT NO. 10
Application Type
S : Standard
D : District Cooling

✔ DIGIT NO. 11
Drain Pan Type
A : Standard Drain Pan
B : Extended Drain Pan
C : Stainless Drain Pan
D : Extended Stainless Drain Pan

✔ DIGIT NO. 12
Unit Connection Direction
(Face to the discharge air)
L : Left
R : Right

✔ DIGIT NO.13
Customer Source & Power
1 : Export to Hong Kong 220V~240V-1Ph-50Hz
2 : Export 220V~240V-1Ph-50Hz
3 : Export 220V~240V-1Ph-60Hz

✔ DIGIT NO. 14
Plenum box & Filter
1 : With Rear Plenum box & 25mm Aluminum Filter

✔ DIGIT NO. 15
Electric heater
0 : Without electric heater
1 : With electric heater

Air Volume

1360~3400m³/h

Features

Ultra low noise

42HS unit is designed for quiet operation , equipped with newly designed wide impeller, forward curved blade, and low speed fan precisely matching the motor.

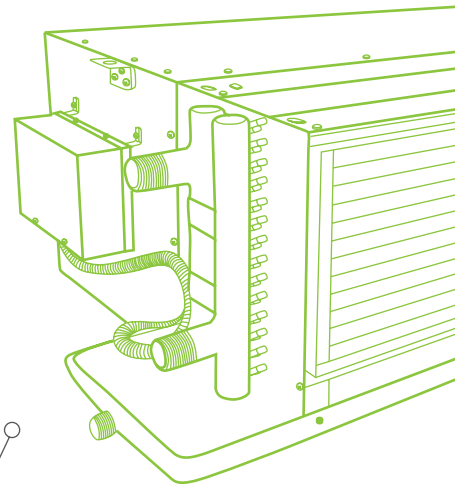
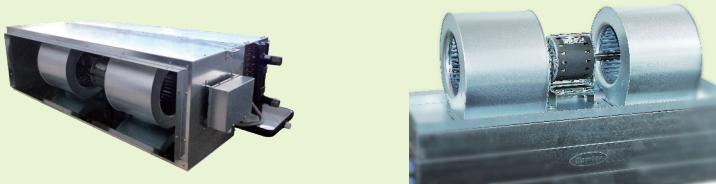

High efficiency

Unit coil using the latest developed double-flanging structure of wide seam blue hydrophilic aluminum fin, advanced mechanical tube-expanding process, ensure copper tube optimally contacts with aluminum fin. Wide seam hydrophilic aluminum fin provide sufficient heat transfer channel for heat exchange, wide impeller provide uniformly air velocity environment for heat transfer. It makes the heat transfer more complete, which ensures the cooling capacity per input power of 42HS outperforms other similar products.

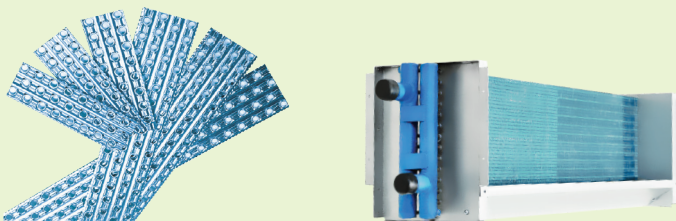

Compact design and low height

Unit height of 42HS is below 403 mm, saving installation space and meet the demand of various situation.

Wide range application

42HS series offer 7 models, air flow range from 1360 to 3400m³/h, with 3 or 4 rows coils type for each model, both in standard and district cooling application, unit can be applied to two or four pipe system, meet various demand of cooling or heating applications. Unit external static pressure range from 0 to 100Pa, flexible for longer duct application.

Diversified options

- 3row/4row/3+1row for standard application
3row/4row for district cooling application
- Thermostat
- Motorized 2-way or 3-way valves
- Drain pan option: Cold roll steel with powder coating or stainless steel, all with 6mm PE insulation(Armalex Class-O).
- Drain pan length option: Standard or Extended design
- Rear plenum box
- Filter: 25mm Aluminum filter
- Motor: 220-240V, 50Hz, IP20, Class F insulation
Non-standard option: 220-240VAC, 60Hz , IP54
- Every unit has a driver on control board, with the feature that thermostats like Carrier's TMS810 can be connected to operate 42HS unit directly.

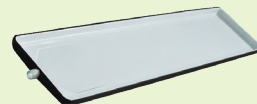

Technical Specification

Model		42HS008	42HS010	42HS012	42HS014	42HS016	42HS018	42HS020
District Cooling Performance								
Nominal Air Flow	m ³ /h	1400	1763	2204	2497	2913	3240	3459
	CFM	824	1037	1296	1469	1714	1906	2085
Nominal Total Capacity	kW	6.2	7.8	9.6	10.6	11.9	12.7	14.2
	Btuh	21145	26495	32866	36332	40748	43498	48415
Water Flow Rate	m ³ /h	0.590	0.742	0.918	1.015	1.141	1.217	1.354
	G.P.M.(US)	2.60	3.27	4.04	4.47	5.02	5.36	5.96
Water Pressure Drop	kPa	38.5	33.1	53.8	28.1	47.9	40.6	37.7
	ft.wg.	12.86	11.05	17.97	9.38	15.99	13.55	12.61
Pipe Connections	In-Out	3/4"Female BSPT						
	Condensing Drain	3/4"Male BSPT						
Standard Cooling Performance								
Nominal Air Flow	m ³ /h	1400	1763	2204	2497	2913	3240	3459
	CFM	824	1037	1296	1469	1714	1906	2085
Nominal Total Capacity	kW	6.3	8.4	10.0	10.7	13.8	14.9	15.6
	Btuh	21350	28532	34193	36537	46958	50762	53345
Water Flow Rate	m ³ /h	1.073	1.436	1.721	1.840	2.365	2.556	2.686
	G.P.M.(US)	4.72	6.32	7.58	8.10	10.41	11.25	11.82
Water Pressure Drop	kPa	21.4	43.7	37.5	34.5	38.4	46.7	44.4
	ft.wg.	7.15	14.61	12.51	11.53	12.81	15.60	14.84
Pipe Connections	In-Out (2 pipe)	1"Male BSPT						
	In-Out (4 pipe)	1"Male BSPT(Cooling) / 3/4"Female BSPT(Heating)						
	Condensing Drain	3/4"Male BSPT						
Coil								
Face Area	m ²	0.20	0.25	0.29	0.33	0.40	0.44	0.49
Face Velocity	m/s	1.94	1.96	2.11	2.10	2.02	2.04	2.01
Motor(220~240V-1Ph-50Hz)								
Type		4 Poles Three - Speed Permanent Split Capacitor Motor						
No. of motor		1	1	1	1	1	1	1
Total Rating Input	W	227	285	364	404	581	653	673
Rated Amp.(220V-1Ph-50Hz)	A	1.03	1.31	1.65	1.84	2.64	2.97	3.06
Motor(220V~240V-1Ph-60Hz)								
Type		4 Poles Permanent Split Capacitor Motor				6 Poles Permanent Split Capacitor Motor		
No. of motor		1	1	1	1	1	1	1
Total Rating Input	W	304	404	538	697	508	519	667
Rated Amp.(220V-1Ph-60Hz)	A	1.38	1.84	2.47	3.19	2.34	2.41	3.05
Fan								
Type		Centrifugal Fan (Forward Curve DIDW)						
No. of Fan		2	2	2	2	2	2	2
Electric Heater								
Power Input	kW	1.5	1.5	1.5	2	3	3	3
Water Content								
3 Rows	L	1.3	1.6	1.9	2.1	2.5	2.8	3.0
4 Rows	L	1.7	2.1	2.5	2.8	3.4	3.8	4.1
3+1 Rows (Cooling/Heating)	L	1.3/0.4	1.6/0.5	1.9/0.6	2.1/0.7	2.5/0.8	2.7/0.9	3.0/1.0

Air Flow: Middle Speed, 30Pa External Static Pressure.

Cooling Capacity For 3 Row Coils at Entering Air Temperature 24°CDB/18°CWB.

For Standard Cooling Coil: Entering Water 7°C, Temperature Rise 5°C.

For District Cooling Coil: Entering Water 5.5°C, Temperature Rise 9°C.

Dimensional Data

Unit Dimensions

UNIT	A	B	C	D	E	F	G	L	L1
42HS008	836	776	298	238	311	833	180	970	1170
42HS010	1036	976	298	238	311	1033	180	1170	1290
42HS012	1036	976	340	280	356	1033	222	1170	1290
42HS014	1156	1096	340	280	356	1153	222	1290	1410
42HS016	1156	1096	403	343	396	1153	285	1290	1410
42HS018	1276	1216	403	343	396	1273	285	1410	1530
42HS020	1396	1336	403	343	396	1393	285	1530	1650

Note: L1-Extended Drain Pan

This drawing is for left connection, right connection is the opposite.

Standard Cooling 2 Pipe

UNIT	TYPE	H	I	J	K
42HS008	3R	100.3	45.4	61	130
42HS010		100.3	45.4	61	130
42HS012		100.3	45.4	61	172
42HS014		100.3	45.4	61	172
42HS016		100.3	45.4	81	215
42HS018		100.3	45.4	81	215
42HS020		100.3	45.4	81	215

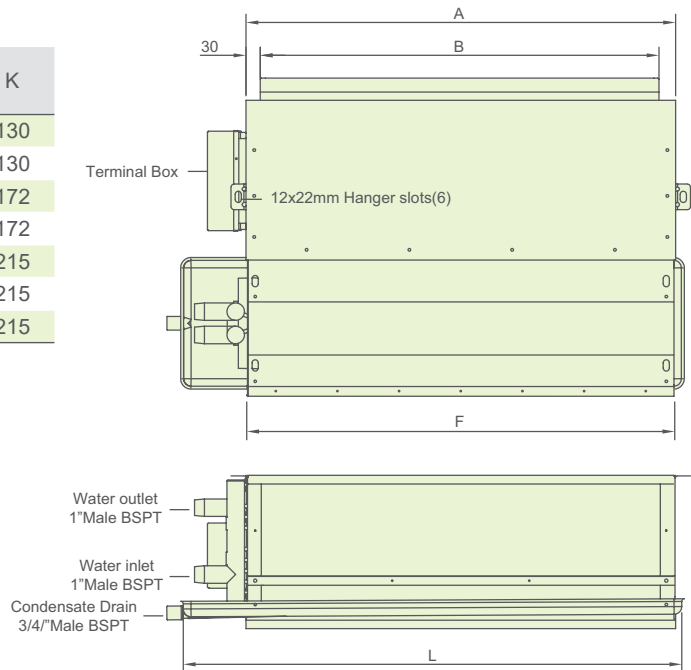
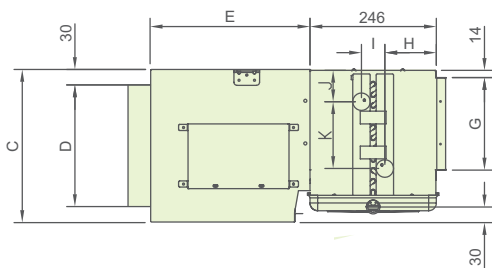

Dimensional Data

Standard Cooling 2 Pipe

UNIT	TYPE	H	I	J	K
42HS008	4R	94	58.1	61	130
42HS010		94	58.1	61	130
42HS012		94	58.1	61	172
42HS014		94	58.1	61	172
42HS016		94	58.1	81	215
42HS018		94	58.1	81	215
42HS020		94	58.1	81	215

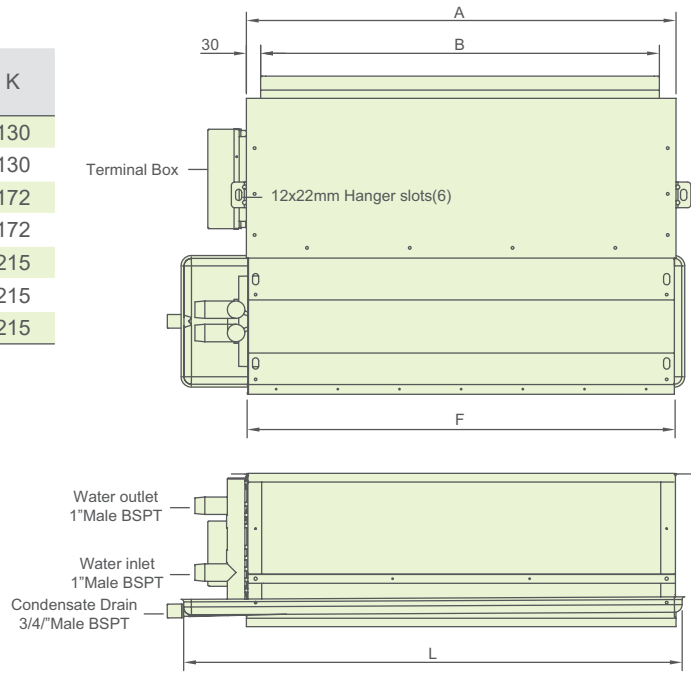
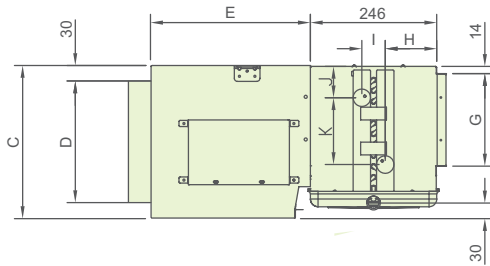

Standard Cooling 4 Pipe

UNIT	TYPE	J	K
42HS008	3+1R	61	130
42HS010		61	130
42HS012		61	172
42HS014		61	172
42HS016		81	215
42HS018		81	215
42HS020		81	215

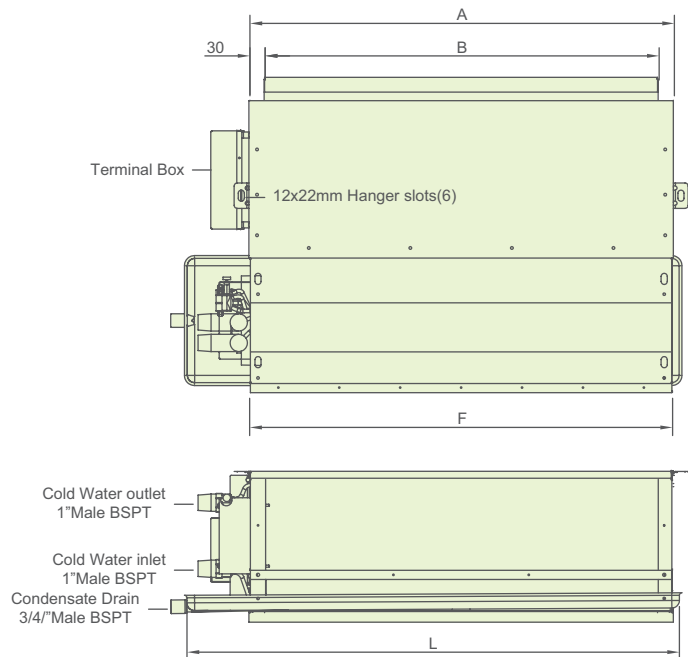
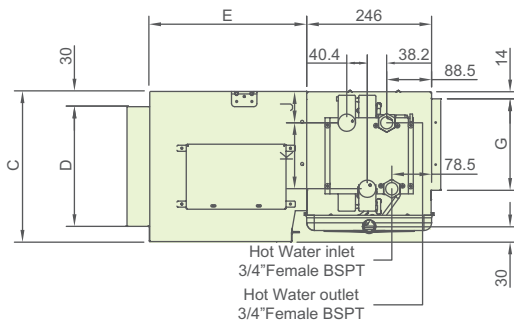

Dimensional Data

District Cooling 2 Pipe

UNIT	TYPE	J	K
42HS008	3R 4R	61	130
42HS010		61	130
42HS012		81	130
42HS014		81	130
42HS016		81	172
42HS018		81	172
42HS020		81	172

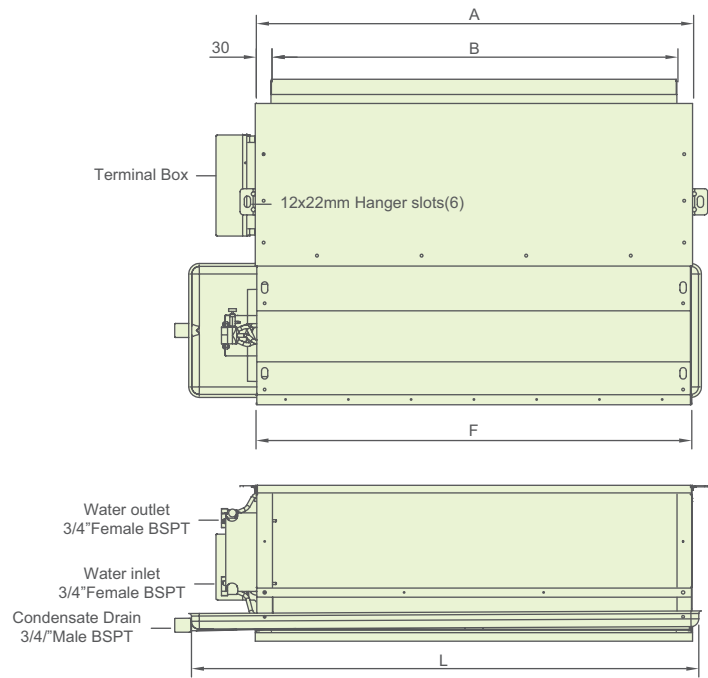
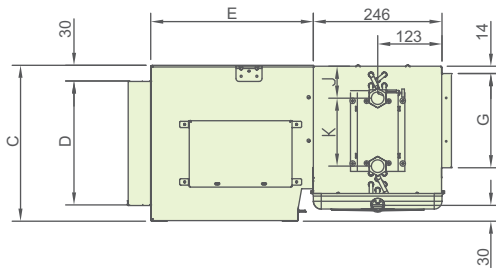

Unit Dimensions and Weights

Model	Length		Width	Height	Weight		
	Standard Drain Pan	Extended Drain Pan			3 Rows	4 Rows	3+1 Rows
42HS008	1000	1200	607	298	36	39	41
42HS010	1200	1320	607	298	40	43.5	45.5
42HS012	1200	1320	652	340	46	50	52
42HS014	1320	1440	652	340	51	55.5	58
42HS016	1320	1440	692	403	57	62.5	65
42HS018	1440	1560	692	403	62	68.5	71
42HS020	1560	1680	692	403	66	73	76

Packaged Dimensions and Weights

Model	Length		Width	Height	Weight		
	Standard Drain Pan	Extended Drain Pan			3 Rows	4 Rows	3+1 Rows
42HS008	1130	1330	390	650	44	47	49
42HS010	1330	1450	390	650	50	53.5	55.5
42HS012	1330	1450	440	700	56	60	62
42HS014	1450	1570	440	700	62	66.5	69
42HS016	1450	1570	500	740	68	73.5	76
42HS018	1570	1690	500	740	74	80.5	83
42HS020	1690	1810	500	740	78	85	88

Performance Data

Standard Cooling 3 Rows 2 Pipe

Model	Speed	ESP	Air Flow	Power Input(50Hz)	Power Input (60Hz)	Capacity		Air Outlet		Water Flow	Water Pressure
						Total	Sensible	DB	WB		
		Pa	m³/h	W	W	kW	kW	°C	°C	l/min	kPa
42HS008	H	20	1484	244	313	6.5	5.0	14.0	13.2	18.60	22.9
		50	1358	226	304	6.1	4.7	13.7	13.1	17.52	20.7
		100	1087	194	291	5.2	3.9	13.3	12.7	15.00	15.8
	M	20	1434	232	291	6.4	4.9	13.9	13.2	18.18	22.0
		50	1321	217	286	6.0	4.6	13.7	13.0	17.22	20.0
		100	1052	184	273	5.1	3.8	13.2	12.7	14.64	15.0
	L	20	732	112	133	3.9	2.8	12.5	12.1	11.16	9.6
		50	647	105	130	3.5	2.5	12.3	12.0	10.08	8.0
		100	436	85	123	2.6	1.8	11.6	11.4	7.32	4.8
42HS010	H	20	2010	322	414	9.1	6.9	13.8	13.1	26.16	49.5
		50	1864	297	404	8.7	6.5	13.6	12.9	24.84	46.5
		100	1557	252	385	7.7	5.7	13.2	12.6	21.96	37.6
	M	20	1806	292	380	8.5	6.3	13.5	12.9	24.30	45.0
		50	1681	269	370	8.1	6.0	13.3	12.7	23.16	41.3
		100	1417	228	354	7.2	5.3	12.9	12.4	20.52	33.6
	L	20	1023	173	183	5.7	4.0	12.2	11.8	16.20	22.5
		50	960	162	179	5.4	3.8	12.1	11.7	15.48	20.6
		100	808	138	171	4.7	3.3	11.7	11.4	13.56	16.3
42HS012	H	20	2376	394	546	10.5	8.0	13.9	13.2	30.12	41.0
		50	2228	376	538	10.1	7.6	13.8	13.1	28.86	38.5
		100	1977	349	528	9.3	7.0	13.5	12.8	26.64	33.0
	M	20	2240	363	494	10.1	7.7	13.8	13.1	28.98	39.0
		50	2124	351	489	9.8	7.4	13.7	13.0	27.96	36.0
		100	1882	334	478	9.0	6.7	13.4	12.8	25.80	31.5
	L	20	1355	176	203	7.1	5.2	12.6	12.2	20.40	21.0
		50	1224	170	200	6.6	4.8	12.4	12.0	18.90	18.2
		100	925	155	194	5.3	3.8	11.9	11.6	15.18	13.0
42HS014	H	20	2807	473	709	11.5	9.0	14.5	13.6	32.94	39.2
		50	2662	455	697	11.2	8.6	14.3	13.5	31.92	37.0
		100	2404	425	672	10.5	8.0	14.1	13.3	29.94	33.2
	M	20	2547	409	636	10.8	8.3	14.2	13.4	31.02	35.3
		50	2429	397	626	10.5	8.1	14.1	13.3	30.18	33.7
		100	2189	368	604	9.8	7.5	13.8	13.1	28.20	30.0
	L	20	1340	168	208	7.0	5.1	12.7	12.2	20.04	16.7
		50	1208	163	204	6.5	4.7	12.5	12.1	18.48	14.3
		100	951	150	197	5.4	3.8	12.1	11.7	15.30	9.8
42HS016	H	20	3199	649	517	14.7	11.1	13.7	13.0	41.94	42.7
		50	2984	631	508	14.0	10.5	13.5	12.9	40.02	41.0
		100	2678	603	476	13.0	9.7	13.2	12.7	37.26	35.0
	M	20	3001	590	462	14.0	10.6	13.5	12.9	40.20	39.7
		50	2790	573	448	13.4	10.0	13.3	12.7	38.28	36.5
		100	2488	548	424	12.4	9.1	13.0	12.5	35.40	31.9
	L	20	1825	291	196	9.9	7.1	12.4	12.0	28.32	22.0
		50	1659	284	194	9.2	6.6	12.2	11.8	26.34	19.1
		100	1273	271	186	7.5	5.3	11.7	11.4	21.36	12.6
42HS018	H	20	3463	714	543	15.6	11.8	13.8	13.1	44.52	50.4
		50	3264	702	519	15.0	11.3	13.7	13.0	42.78	47.0
		100	2958	679	482	14.0	10.5	13.4	12.8	40.08	42.0
	M	20	3305	653	485	15.1	11.4	13.7	13.0	43.14	47.7
		50	3126	650	465	14.5	10.9	13.6	12.9	41.64	45.0
		100	2779	626	434	13.4	10.0	13.3	12.7	38.40	39.0
	L	20	1878	291	208	10.0	7.2	12.4	12.0	28.62	23.7
		50	1659	285	204	9.2	6.6	12.2	11.8	26.40	20.5
		100	1332	276	191	7.8	5.5	11.7	11.5	22.26	14.7
42HS020	H	20	3763	750	694	16.5	12.5	14.0	13.2	47.22	48.0
		50	3566	742	667	16.0	12.1	13.9	13.1	45.66	46.0
		100	3226	713	623	14.9	11.2	13.7	13.0	42.72	41.0
	M	20	3533	674	585	15.9	12.0	13.9	13.1	45.36	45.0
		50	3318	663	556	15.2	11.4	13.7	13.0	43.50	42.0
		100	3017	644	512	14.3	10.6	13.5	12.8	40.80	37.8
	L	20	1905	281	308	10.3	7.4	12.4	12.0	29.46	21.6
		50	1698	276	301	9.5	6.7	12.2	11.8	27.06	18.8
		100	1340	267	284	7.8	5.5	11.7	11.4	22.44	13.1

Air Conditions: Air Inlet DB24/WB18°C.
Entering Water 7°C, Leaving WSP 12°C.

Performance Data

Standard Cooling 4 Rows 2 Pipe

Model	Speed	ESP	Air Flow	Power Input(50Hz)	Power Input(60Hz)	Capacity		Air Outlet		Water Flow	Water Pressure
		Pa	m ³ /h	W	W	Total kW	Sensible kW	DB °C	WB °C		
42HS008	H	20	1484	244	313	7.7	5.6	12.8	12.3	21.96	29.3
		50	1358	226	304	7.2	5.2	12.6	12.1	20.64	26.3
		100	1087	194	291	6.2	4.4	12.0	11.7	17.64	20.0
	M	20	1434	232	291	7.5	5.4	12.7	12.2	21.42	28.1
		50	1321	217	286	7.1	5.1	12.5	12.1	20.22	25.4
		100	1052	184	273	6.0	4.2	12.0	11.6	17.16	19.4
	L	20	732	112	133	4.5	3.1	11.3	11.1	12.90	11.2
		50	647	105	130	4.1	2.8	11.1	10.9	11.70	9.1
		100	436	85	123	2.9	2.0	10.5	10.3	8.40	4.7
42HS010	H	20	2010	322	414	10.4	7.6	12.8	12.3	29.70	42.8
		50	1864	297	404	9.8	7.1	12.6	12.2	28.14	39.0
		100	1557	252	385	8.7	6.2	12.2	11.8	24.78	31.3
	M	20	1806	292	380	9.6	6.9	12.5	12.1	27.54	37.6
		50	1681	269	370	9.1	6.6	12.4	12.0	26.16	34.4
		100	1417	228	354	8.1	5.7	12.0	11.6	23.16	27.8
	L	20	1023	173	183	6.3	4.4	11.3	11.1	18.00	17.9
		50	960	162	179	6.0	4.1	11.2	11.0	17.10	16.4
		100	808	138	171	5.2	3.6	10.9	10.7	14.88	12.4
42HS012	H	20	2376	394	546	11.9	8.8	13.0	12.5	34.20	45.2
		50	2228	376	538	11.4	8.3	12.8	12.4	32.70	41.8
		100	1977	349	528	10.5	7.6	12.5	12.1	30.06	36.2
	M	20	2240	363	494	11.5	8.4	12.8	12.4	32.82	42.1
		50	2124	351	489	11.0	8.0	12.7	12.3	31.62	39.5
		100	1882	334	478	10.1	7.3	12.4	12.0	29.04	34.1
	L	20	1355	176	203	7.9	5.6	11.7	11.5	22.68	22.2
		50	1224	170	200	7.3	5.1	11.5	11.3	21.00	19.4
		100	925	155	194	5.8	4.0	11.0	10.9	16.68	12.3
42HS014	H	20	2807	473	709	13.1	9.8	13.5	12.9	37.62	49.4
		50	2662	455	697	12.7	9.5	13.4	12.8	36.30	46.5
		100	2404	425	672	11.8	8.7	13.1	12.6	33.90	41.3
	M	20	2547	409	636	12.3	9.1	13.3	12.7	35.22	44.2
		50	2429	397	626	11.9	8.8	13.2	12.6	34.14	41.8
		100	2189	368	604	11.1	8.1	12.9	12.4	31.80	37.0
	L	20	1340	168	208	7.7	5.5	11.9	11.6	22.14	19.5
		50	1208	163	204	7.1	5.0	11.7	11.4	20.40	16.6
		100	951	150	197	5.9	4.1	11.3	11.0	16.80	11.3
42HS016	H	20	3199	649	517	17.1	12.3	12.5	12.1	48.90	50.3
		50	2984	631	508	16.3	11.7	12.3	12.0	46.56	46.2
		100	2678	603	476	15.1	10.7	12.1	11.7	43.08	40.4
	M	20	3001	590	462	16.3	11.7	12.3	12.0	46.74	46.5
		50	2790	573	448	15.5	11.1	12.2	11.8	44.34	42.5
		100	2488	548	424	14.3	10.1	11.9	11.6	40.80	36.8
	L	20	1825	291	196	11.3	7.8	11.3	11.0	32.22	24.4
		50	1659	284	194	10.5	7.2	11.1	10.9	29.94	21.6
		100	1273	271	186	8.4	5.7	10.6	10.5	24.06	14.0
42HS018	H	20	3463	714	543	18.0	13.1	12.7	12.3	51.60	55.9
		50	3264	702	519	17.4	12.6	12.5	12.1	49.80	52.6
		100	2958	679	482	16.2	11.6	12.3	11.9	46.50	46.7
	M	20	3305	653	485	17.6	12.7	12.6	12.1	50.22	53.4
		50	3126	650	465	16.9	12.1	12.4	12.0	48.30	49.9
		100	2779	626	434	15.5	11.1	12.1	11.8	44.46	43.2
	L	20	1878	291	208	11.6	8.0	11.3	11.1	33.06	25.9
		50	1659	285	204	10.5	7.2	11.1	10.9	29.94	21.2
		100	1332	276	191	8.7	5.9	10.7	10.6	24.96	14.8
42HS020	H	20	3763	750	694	18.5	13.7	13.1	12.6	53.10	33.0
		50	3566	742	667	17.9	13.1	13.0	13.5	51.12	31.0
		100	3226	713	623	16.7	12.1	12.8	12.3	47.70	27.5
	M	20	3533	674	585	17.8	13.0	13.0	12.7	50.82	30.6
		50	3318	663	556	17.0	12.4	12.8	12.3	48.66	28.4
		100	3017	644	512	15.9	11.5	12.6	12.2	45.48	25.3
	L	20	1905	281	308	11.7	8.1	11.3	11.1	33.60	14.7
		50	1698	276	301	10.7	7.4	11.1	10.9	30.60	12.3
		100	1340	267	284	8.8	6.0	10.7	10.5	25.20	8.9

Air Conditions: Air Inlet DB24/WB18°C.
 Entering Water 7°C, Leaving Water 12°C.

Performance Data

District Cooling 3 Rows 2 Pipe

Model	Speed	ESP Pa	Air Flow m ³ /h	Power Input(50Hz) W	Power Input(60Hz) W	Capacity		Air Outlet		Water Flow l/min	Water Pressure kPa
						Total kW	Sensible kW	DB °C	WB °C		
42HS008	H	20	1484	244	313	6.4	5.0	14.0	13.3	10.26	41.2
		50	1358	226	304	6.1	4.6	13.8	13.1	9.66	34.0
		100	1087	194	291	5.2	3.9	13.3	12.8	8.28	28.5
	M	20	1434	232	291	6.3	4.8	13.9	13.2	10.02	39.6
		50	1321	217	286	6.0	4.6	13.7	13.1	9.48	36.0
		100	1052	184	273	5.1	3.8	13.2	12.7	8.10	27.3
	L	20	732	112	133	3.9	2.8	12.5	12.2	6.12	16.1
		50	647	105	130	3.5	2.5	12.3	12.0	5.58	13.3
		100	436	85	123	2.6	1.8	11.6	11.5	4.08	7.1
42HS010	H	20	2010	322	414	8.5	6.6	14.2	13.4	13.50	38.5
		50	1864	297	404	8.1	6.2	14.0	13.3	12.84	35.3
		100	1557	252	385	7.1	5.4	13.6	13.0	11.34	28.6
	M	20	1806	292	380	7.9	6.1	13.9	13.3	12.54	34.0
		50	1681	269	370	7.5	5.8	13.8	13.1	11.94	31.3
		100	1417	228	354	6.7	5.0	13.4	12.8	10.62	25.7
	L	20	1023	173	183	5.3	3.9	12.7	12.3	8.34	16.3
		50	960	162	179	5.0	3.7	12.6	12.2	7.98	14.8
		100	808	138	171	4.4	3.2	12.3	12.0	6.96	11.3
42HS012	H	20	2376	394	546	10.1	7.8	14.2	13.4	16.08	58.7
		50	2228	376	538	9.7	7.4	14.0	13.3	15.42	54.5
		100	1977	349	528	9.0	6.8	13.7	13.1	14.22	47.5
	M	20	2240	363	494	9.7	7.5	14.0	13.3	15.48	54.9
		50	2124	351	489	9.4	7.2	13.9	13.2	14.94	51.6
		100	1882	334	478	8.7	6.5	13.6	13.0	13.80	44.8
	L	20	1355	176	203	6.9	5.1	12.9	12.4	10.92	30.2
		50	1224	170	200	6.4	4.7	12.6	12.2	10.20	27.0
		100	925	155	194	5.2	3.7	12.1	11.8	8.22	17.6
42HS014	H	20	2807	473	709	11.5	9.0	14.4	13.6	18.24	32.0
		50	2662	455	697	11.1	8.7	14.3	13.5	17.64	30.2
		100	2404	425	672	10.4	8.0	14.0	13.3	16.50	26.9
	M	20	2547	409	636	10.8	8.4	14.2	13.4	17.16	28.7
		50	2429	397	626	10.5	8.1	14.1	13.3	16.62	27.2
		100	2189	368	604	9.8	7.5	13.8	13.2	15.54	24.1
	L	20	1340	168	208	6.8	5.0	12.8	12.4	10.80	12.2
		50	1208	163	204	6.3	4.6	12.6	12.3	9.96	10.4
		100	951	150	197	5.2	3.8	12.2	11.9	8.28	7.2
42HS016	H	20	3199	649	517	12.7	10.0	14.6	13.7	20.16	48.3
		50	2984	631	508	12.1	9.5	14.5	13.6	19.32	49.2
		100	2678	603	476	11.3	8.8	14.2	13.4	17.94	43.5
	M	20	3001	590	462	12.2	9.6	14.5	13.6	19.38	49.5
		50	2790	573	448	11.6	9.1	14.3	13.5	18.48	45.6
		100	2488	548	424	10.7	8.3	14.0	13.3	17.10	39.9
	L	20	1825	291	196	8.6	6.5	13.4	12.8	13.74	27.2
		50	1659	284	194	8.0	6.0	13.2	12.7	12.78	23.8
		100	1273	271	186	6.6	4.8	12.7	12.3	10.50	16.1
42HS018	H	20	3463	714	543	13.3	10.6	14.8	13.9	21.18	43.7
		50	3264	702	519	12.8	10.2	14.7	13.8	20.40	40.9
		100	2958	679	482	12.0	9.4	14.5	13.6	19.08	36.5
	M	20	3305	653	485	12.9	10.3	14.7	13.8	20.52	41.5
		50	3126	650	465	12.5	9.8	14.6	13.7	19.80	38.9
		100	2779	626	434	11.5	9.0	14.3	13.5	18.24	34.0
	L	20	1878	291	208	8.7	6.6	13.5	12.9	13.86	20.6
		50	1659	285	204	7.9	6.0	13.3	12.8	12.60	17.1
		100	1332	276	191	6.7	5.0	12.9	12.5	10.62	12.2
42HS020	H	20	3763	750	694	15.0	11.8	14.6	13.7	23.82	41.4
		50	3566	742	667	14.5	11.4	14.5	13.6	23.04	39.0
		100	3226	713	623	13.6	10.5	14.2	13.5	21.54	34.9
	M	20	3533	674	585	14.4	11.3	14.5	13.6	22.86	38.6
		50	3318	663	556	13.8	10.8	14.3	13.5	21.96	36.0
		100	3017	644	512	13.0	10.0	14.1	13.3	20.58	32.3
	L	20	1905	281	308	9.3	6.9	13.1	12.6	14.82	17.6
		50	1698	276	301	8.5	6.3	12.9	12.5	13.56	14.8
		100	1340	267	284	7.1	5.2	12.5	12.1	11.28	10.2

Air Conditions: Air Inlet DB24/WB18°C.

Entering Water 5.5°C, Leaving Water 14.5°C.

Performance Data

District Cooling 4 Rows 2 Pipe

Model	Speed	ESP Pa	Air Flow m ³ /h	Power Input(50HZ) W	Power Input(60HZ) W	Capacity		Air Outlet		Water Flow l/min	Water Pressure kPa
						Total kW	Sensible kW	DB °C	WB °C		
42HS008	H	20	1484	244	313	7.4	5.5	13.0	12.5	11.70	37.9
		50	1358	226	304	6.9	5.1	12.8	12.4	11.04	34.0
		100	1087	194	291	5.9	4.3	12.3	12.0	9.36	25.6
	M	20	1434	232	291	7.2	5.3	12.9	12.5	11.46	36.3
		50	1321	217	286	6.8	5.0	12.7	12.3	10.80	32.9
		100	1052	184	273	5.7	4.1	12.2	11.9	9.12	24.4
	L	20	732	112	133	4.3	3.1	11.6	11.4	6.90	14.0
		50	647	105	130	3.9	2.7	11.3	11.2	6.24	11.5
		100	436	84.5	123	2.8	1.9	10.7	10.6	4.50	6.0
42HS010	H	20	2010	322	414	9.4	7.1	13.4	12.9	14.88	24.5
		50	1864	297	404	8.9	6.7	13.3	12.8	14.16	22.2
		100	1557	252	385	7.8	5.8	12.9	12.5	12.42	17.4
	M	20	1806	292	380	8.7	6.5	13.2	12.7	13.86	21.7
		50	1681	269	370	8.3	6.2	13.0	12.6	13.14	19.5
		100	1417	228	354	7.3	5.4	12.7	12.3	11.58	15.1
	L	20	1023	173	183	5.7	4.1	12.1	11.9	9.00	9.2
		50	960	162	179	5.4	3.9	12.0	11.8	8.58	8.3
		100	808	138	171	4.7	3.3	11.7	11.5	7.44	6.3
42HS012	H	20	2376	394	546	11.4	8.5	13.3	12.8	18.06	38.4
		50	2228	376	538	10.9	8.1	13.1	12.6	17.34	35.7
		100	1977	349	528	10.0	7.4	12.9	12.4	15.96	31.0
	M	20	2240	363	494	10.9	8.1	13.2	12.6	17.40	35.9
		50	2124	351	489	10.5	7.8	13.0	12.5	16.80	33.7
		100	1882	334	478	9.7	7.1	12.7	12.3	15.42	29.2
	L	20	1355	176	203	7.6	5.4	12.0	11.8	12.12	18.7
		50	1224	170	200	7.0	5.0	11.8	11.6	11.16	16.0
		100	925	155	194	5.6	3.9	11.3	11.2	8.94	10.3
42HS014	H	20	2807	473	709	12.9	9.8	13.6	13.0	20.46	26.0
		50	2662	455	697	12.4	9.4	13.5	12.9	19.74	24.4
		100	2404	425	672	11.6	8.7	13.2	12.7	18.42	22.0
	M	20	2547	409	636	12.0	9.1	13.4	12.8	19.14	23.2
		50	2429	397	626	11.6	8.8	13.2	12.7	18.54	22.4
		100	2189	368	604	10.8	8.1	13.0	12.6	17.22	19.3
	L	20	1340	168	208	7.4	5.4	12.1	11.8	11.82	9.2
		50	1208	163	204	6.9	4.9	11.9	11.7	10.92	7.8
		100	951	150	197	5.7	4.0	11.5	11.3	9.00	5.3
42HS016	H	20	3199	649	517	15.2	11.4	13.4	12.8	24.18	51.8
		50	2984	631	508	14.5	10.8	13.2	12.7	23.10	47.7
		100	2678	603	476	13.5	10.0	12.9	12.4	21.48	42.2
	M	20	3001	590	462	14.6	10.9	13.2	12.7	23.16	48.0
		50	2790	573	448	13.9	10.3	13.0	12.5	22.08	44.3
		100	2488	548	424	12.8	9.4	12.7	12.3	20.40	38.6
	L	20	1825	291	196	10.2	7.3	12.1	11.8	16.26	25.7
		50	1659	284	194	9.5	6.7	11.9	11.6	15.12	22.2
		100	1273	271	186	7.7	5.4	11.4	11.2	12.24	14.6
42HS018	H	20	3463	714	543	16.1	12.2	13.5	12.9	25.62	36.5
		50	3264	702	519	15.5	11.6	13.4	12.8	24.60	34.1
		100	2958	679	482	14.5	10.8	13.1	12.6	22.98	30.6
	M	20	3305	653	485	15.6	11.7	13.4	12.8	24.84	34.6
		50	3126	650	465	15.0	11.2	13.3	12.7	23.88	32.4
		100	2779	626	434	13.8	10.3	13.0	12.5	22.02	28.4
	L	20	1878	291	208	10.3	7.4	12.2	11.9	16.38	15.8
		50	1659	285	204	9.4	6.7	12.0	11.7	14.88	13.1
		100	1332	276	191	7.9	5.5	11.6	11.4	12.48	9.2
42HS020	H	20	3763	750	694	17.2	13.1	13.6	13.0	27.36	32.8
		50	3566	742	667	16.6	12.6	13.5	12.9	26.34	30.8
		100	3226	713	623	15.4	11.6	13.3	12.8	24.54	27.5
	M	20	3533	674	585	16.5	12.5	13.5	12.9	26.16	30.5
		50	3318	663	556	15.7	11.9	13.3	12.8	25.02	28.5
		100	3017	644	512	14.7	11.0	13.1	12.7	23.40	25.1
	L	20	1905	281	308	10.4	7.5	12.2	11.9	16.56	12.7
		50	1698	276	301	9.5	6.8	12.0	11.8	15.12	10.6
		100	1340	267	284	7.9	5.6	11.6	11.4	12.54	7.3

Air Conditions: Air Inlet DB24/WB18°C.

Entering Water 5.5°C, Leaving Water 14.5°C.

Performance Data

Standard Cooling 3+1 Rows 4 Pipe

Model	Speed	ESP	Air Flow	Power Input(50Hz)	Power Input(60Hz)	Capacity		Air Outlet		Water Flow	Water Pressure	Heating Capacity	Air Outlet	Water Flow	Water Pressure
		Pa	m³/h	W	W	kW	kW	DB °C	WB °C	l/min	kPa	kW	°C	l/min	kPa
42HS008	H	20	1484	244	313	6.5	4.9	14.2	13.3	18.48	35.7	3.2	26.4	4.62	5.7
		50	1358	226	304	6.1	4.6	13.9	13.1	17.46	32.3	3.0	26.6	4.44	5.2
		100	1087	194	291	5.3	3.9	13.3	12.7	15.12	25.3	2.7	27.3	3.84	4.2
	M	20	1434	232	291	6.3	4.8	14.1	13.2	18.06	34.4	3.1	26.5	4.56	5.5
		50	1321	217	286	6.0	4.4	13.9	13.1	17.10	31.3	3.0	26.7	4.32	5.1
		100	1052	184	273	5.2	3.8	13.2	12.6	14.82	24.3	2.6	27.4	3.78	4.0
	L	20	732	112	133	4.0	2.8	12.4	12.0	11.40	16.4	2.1	28.4	3.00	2.7
		50	647	105	130	3.6	2.6	12.2	11.8	10.32	13.5	1.9	28.8	2.76	2.4
		100	436	85	123	2.6	1.8	11.5	11.2	7.56	7.2	1.5	29.9	2.10	1.4
42HS010	H	20	2010	322	414	8.5	6.5	14.3	13.4	24.42	51.3	4.1	26.0	5.94	10.9
		50	1864	297	404	8.1	6.1	14.2	13.3	23.22	47.1	3.9	26.2	5.70	10.1
		100	1557	252	385	7.2	5.4	13.7	13.0	20.64	38.2	3.5	26.7	5.10	8.4
	M	20	1806	292	380	8.0	6.0	14.1	13.2	22.74	45.4	3.8	26.3	5.58	9.8
		50	1681	269	370	7.6	5.7	13.9	13.1	21.72	41.8	3.7	26.5	5.34	9.1
		100	1417	228	354	6.7	5.0	13.5	12.8	19.32	34.2	3.3	27.0	4.86	7.6
	L	20	1023	173	183	5.4	3.9	12.7	12.2	15.36	23.1	2.7	27.9	3.96	5.4
		50	960	162	179	5.1	3.7	12.6	12.1	14.64	21.2	2.6	28.1	3.78	5.0
		100	808	138	171	4.5	3.2	12.2	11.8	12.84	16.7	2.3	28.6	3.42	4.1
42HS012	H	20	2376	394	546	9.8	7.6	14.5	13.5	28.20	36.3	4.8	25.9	6.90	7.0
		50	2228	376	538	9.4	7.2	14.3	13.4	27.06	33.8	4.6	26.1	6.66	6.5
		100	1977	349	528	8.7	6.6	14.0	13.2	25.02	29.5	4.3	26.4	6.24	5.8
	M	20	2240	363	494	9.5	7.3	14.3	13.4	27.12	34.0	4.6	26.1	6.66	6.6
		50	2124	351	489	9.2	7.0	14.2	13.3	26.22	32.0	4.5	26.2	6.48	6.2
		100	1882	334	478	8.5	6.4	13.9	13.1	24.18	27.9	4.2	26.6	6.06	5.5
	L	20	1355	176	203	6.7	4.9	13.1	12.5	19.26	18.8	3.4	27.4	4.92	3.9
		50	1224	170	200	6.3	4.6	12.9	12.4	17.88	16.7	3.2	27.7	4.62	3.5
		100	925	155	194	5.0	3.6	12.4	12.0	14.40	10.9	2.7	28.5	3.84	2.5
42HS014	H	20	2807	473	709	11.1	8.6	14.8	13.7	31.86	48.5	6.0	26.3	8.64	11.5
		50	2662	455	697	10.8	8.3	14.7	13.6	30.84	45.8	5.8	26.4	8.40	10.9
		100	2404	425	672	10.1	7.7	14.4	13.5	28.86	40.9	5.4	26.7	7.92	9.8
	M	20	2547	409	636	10.5	8.0	14.6	13.6	29.94	43.6	5.6	26.6	8.16	10.4
		50	2429	397	626	10.2	7.8	14.5	13.5	29.04	41.4	5.5	26.7	7.98	9.9
		100	2189	368	604	9.5	7.2	14.2	13.3	27.18	36.8	5.2	27.0	7.50	8.9
	L	20	1340	168	208	6.8	4.9	13.0	12.4	19.38	20.5	3.8	28.4	5.52	5.2
		50	1208	163	204	6.3	4.5	12.8	12.3	17.94	18.1	3.5	28.7	5.16	4.7
		100	951	150	197	5.2	3.7	12.3	11.9	14.94	12.6	3.0	29.4	4.38	3.6
42HS016	H	20	3199	649	517	14.1	10.7	14.1	13.2	40.38	50.8	6.7	26.2	9.72	8.5
		50	2984	631	508	13.5	10.1	13.9	13.1	38.64	47.0	6.4	26.4	9.30	7.9
		100	2678	603	476	12.6	9.3	13.6	12.9	35.94	41.5	6.0	26.7	8.76	7.0
	M	20	3001	590	462	13.5	10.2	13.9	13.1	38.76	47.3	6.4	26.4	9.36	7.9
		50	2790	573	448	12.9	9.6	13.7	13.0	36.96	43.5	6.2	26.6	8.94	7.4
		100	2488	548	424	11.9	8.8	13.4	12.7	34.20	38.1	5.8	26.9	8.34	6.5
	L	20	1825	291	196	9.6	6.9	12.7	12.2	27.48	26.1	4.7	27.7	6.90	4.7
		50	1659	284	194	9.0	6.4	12.5	12.0	25.62	23.2	4.5	28.0	6.48	4.2
		100	1273	271	186	7.3	5.1	12.0	11.6	20.88	15.7	3.7	28.7	5.40	3.1
42HS018	H	20	3463	714	543	14.5	11.1	14.4	13.5	41.52	47.6	7.4	26.4	10.80	11.2
		50	3264	702	519	14.0	10.7	14.3	13.4	39.96	44.5	7.2	26.5	10.44	10.6
		100	2958	679	482	13.1	9.9	14.0	13.2	37.56	40.0	6.8	26.8	9.84	9.5
	M	20	3305	653	485	14.1	10.8	14.3	13.4	40.32	45.2	7.2	26.5	10.50	10.7
		50	3126	650	465	13.6	10.3	14.1	13.3	38.94	42.6	7.0	26.6	10.14	10.1
		100	2779	626	434	12.6	9.5	13.8	13.1	36.00	37.2	6.5	27.0	9.48	8.9
	L	20	1878	291	208	9.6	7.0	12.9	12.4	27.42	23.5	5.1	28.0	7.38	5.8
		50	1659	285	204	8.7	6.3	12.7	12.2	25.02	19.6	4.7	28.4	6.78	5.1
		100	1332	276	191	7.4	5.3	12.2	11.8	21.18	14.2	4.0	29.0	5.88	3.9
42HS020	H	20	3763	750	694	15.8	12.1	14.4	13.5	45.18	48.2	8.2	26.5	11.94	14.7
		50	3566	742	667	15.3	11.6	14.3	13.4	43.68	45.4	8.0	26.6	11.58	13.9
		100	3226	713	623	14.3	10.8	14.0	13.2	40.86	40.5	7.5	26.9	10.86	12.5
	M	20	3533	674	585	15.2	11.5	14.3	13.4	43.38	44.9	7.9	26.6	11.52	13.7
		50	3318	663	556	14.6	11.0	14.1	13.2	41.64	41.8	7.6	26.8	11.04	12.9
		100	3017	644	512	13.7	10.2	13.9	13.1	39.06	37.5	7.2	27.1	10.44	11.6
	L	20	1905	281	308	10.0	7.2	12.7	12.2	28.50	22.2	5.4	28.4	7.80	7.0
		50	1698	276	301	9.1	6.5	12.5	12.0	26.16	18.7	5.0	28.7	7.20	6.1
		100	1340	267	284	7.6	5.4	12.0	11.7	21.78	13.1	4.2	29.4	6.12	4.7

Cooling Air Conditions: Air Inlet DB24/WB18°C, Entering Water 7°C, Leaving Water 12°C.

Heating Air Conditions: Air Inlet 20°C, Entering Water 50°C, Leaving Water 40°C.

Acoustics

Sound Pressure Level

Follows JBstandardJB/T 4330-1999

Model	Speed	ESP	Octave Band & Center Frequency (Hz)								dB(A)
		Pa	63	125	250	500	1000	2000	4000	8000	
42HS008	High	20	20.7	38.5	47.5	49.6	52.7	44.5	41.2	34.4	55.9
		50	20.4	38.0	47.0	49.5	52.3	43.6	40.6	33.6	55.5
		100	21.4	37.9	46.2	48.0	51.4	41.9	38.7	31.0	54.4
	Medium	20	19.6	38.1	46.6	49.9	52.5	44.1	40.5	33.4	55.7
		50	20.4	37.9	47.0	49.0	52.4	43.5	40.3	33.3	55.4
		100	21.0	38.1	46.2	47.6	50.9	41.3	38.3	30.8	54.0
	Low	20	11.1	25.9	33.9	35.6	38.7	28.5	23.4	15.7	41.7
		50	13.7	28.1	36.8	38.2	40.7	30.9	25.7	17.3	44.1
		100	18.4	31.2	39.2	42.1	44.2	34.5	29.6	20.0	47.5
42HS010	High	20	21.9	38.8	47.1	50.2	53.7	45.5	44.1	37.7	56.7
		50	23.2	39.8	47.4	49.2	53.1	44.4	43.4	36.0	56.1
		100	21.3	38.4	46.6	48.8	51.9	43.6	41.6	33.5	55.1
	Medium	20	21.1	37.4	45.9	48.2	51.6	42.8	41.4	33.9	54.7
		50	21.3	38.2	45.7	47.4	51.6	42.8	41.5	33.6	54.4
		100	19.8	37.3	45.2	47.3	50.3	42.1	39.9	30.8	53.6
	Low	20	11.5	27.0	34.5	37.2	39.7	30.2	26.5	16.8	42.9
		50	12.8	29.2	36.3	39.0	41.0	32.0	27.6	17.3	44.5
		100	18.5	34.1	41.2	43.0	44.9	36.4	32.2	21.3	48.7
42HS012	High	20	21.4	42.3	48.5	50.9	52.9	46.3	44.9	38.8	56.9
		50	22.2	42.0	48.9	50.3	52.8	45.8	44.0	37.3	56.7
		100	21.7	42.3	48.0	49.5	52.6	45.1	42.7	35.3	56.1
	Medium	20	15.9	35.5	40.8	43.6	46.3	38.5	35.6	25.3	49.6
		50	17.8	36.0	41.5	44.3	46.4	39.3	36.1	26.0	50.1
		100	18.7	36.9	42.0	44.3	47.0	39.6	35.9	25.0	50.5
	Low	20	13.1	31.1	35.9	39.1	41.0	33.3	28.9	18.2	44.6
		50	14.1	31.6	36.4	40.0	42.2	34.1	29.2	18.3	45.6
		100	19.9	36.1	41.4	43.8	45.9	37.7	32.0	20.1	49.5
42HS014	High	20	23.5	45.5	50.7	51.9	53.7	49.0	46.3	30.0	58.3
		50	24.8	44.7	50.2	51.5	54.0	49.0	45.9	29.4	58.2
		100	24.5	44.1	49.7	49.9	53.2	47.1	44.5	27.3	57.1
	Medium	20	23.0	43.2	48.8	50.1	52.0	46.7	43.9	26.6	56.4
		50	23.3	43.1	48.4	49.9	52.3	46.6	44.1	26.6	56.4
		100	22.9	43.2	47.3	48.6	51.4	45.3	42.6	24.7	55.3
	Low	20	13.7	28.5	31.8	35.1	37.3	30.8	25.6	12.7	41.0
		50	14.1	29.2	33.2	36.0	38.3	31.5	25.9	12.6	42.0
		100	19.0	34.9	37.7	39.6	42.0	35.2	29.9	13.6	45.9
42HS016	High	20	24.3	45.2	50.0	54.1	53.2	48.3	47.5	42.2	58.7
		50	26.9	45.8	50.2	53.7	53.8	48.4	47.4	42.1	58.8
		100	25.6	45.8	49.7	53.1	53.1	47.5	46.2	39.9	58.2
	Medium	20	23.7	44.1	48.7	52.7	51.6	46.7	46.0	39.9	57.3
		50	25.3	44.1	48.2	52.2	51.9	46.6	46.2	40.1	57.1
		100	26.2	44.4	48.6	52.5	52.1	46.5	45.1	37.9	57.2
	Low	20	17.2	33.5	37.5	44.3	41.3	35.8	33.5	22.9	47.4
		50	18.6	35.0	39.4	44.6	42.6	36.4	33.7	23.1	48.2
		100	22.9	38.3	43.0	47.3	45.9	39.5	36.0	25.0	51.3
42HS018	High	20	27.5	46.5	51.4	53.1	53.3	49.4	48.4	42.9	58.9
		50	26.2	45.8	50.7	53.0	53.6	49.2	48.3	42.6	58.8
		100	26.5	45.2	51.4	52.5	52.8	48.5	47.2	40.7	58.3
	Medium	20	25.2	45.5	51.7	52.2	52.0	48.6	47.5	41.4	58.0
		50	25.6	44.2	49.4	52.1	52.1	48.1	47.1	40.4	57.6
		100	26.8	44.5	49.8	51.6	51.9	47.9	46.5	39.1	57.3
	Low	20	17.5	32.3	37.9	40.8	40.1	36.4	33.7	22.6	45.7
		50	19.9	33.8	38.3	41.4	40.2	36.4	33.6	21.9	46.0
		100	22.9	37.1	41.5	44.2	43.3	39.2	35.6	24.0	49.0
42HS020	High	20	27.9	46.5	52.5	54.6	53.8	50.1	48.6	43.9	59.8
		50	27.5	45.1	52.3	54.4	53.4	49.8	48.3	43.2	59.5
		100	27.8	44.8	51.3	53.3	52.9	49.3	47.6	41.7	58.6
	Medium	20	26.5	44.6	50.3	53.2	52.1	48.6	46.8	41.1	58.1
		50	26.7	44.8	50.5	53.3	52.4	48.8	47.0	41.4	58.3
		100	26.3	44.4	50.1	53.1	52.0	48.4	46.6	40.8	58.0
	Low	20	17.0	32.4	39.2	42.2	40.0	36.2	35.1	24.3	46.5
		50	19.2	33.3	39.9	42.8	40.7	37.0	34.5	24.0	47.1
		100	22.8	37.8	43.3	45.3	43.5	40.4	36.2	25.1	50.0

Acoustics

Sound Power Level

Follows JBstandardJB/T 4330-1999

Model	Speed	ESP	Octave Band & Center Frequency (Hz)								dB(A)
		Pa	63	125	250	500	1000	2000	4000	8000	
42HS008	High	20	34.4	52.2	61.2	63.3	66.4	58.2	54.9	48.1	69.6
		50	34.1	51.7	60.7	63.2	66.0	57.3	54.3	47.3	69.2
		100	35.1	51.6	59.9	61.7	65.1	55.6	52.4	44.7	68.1
	Medium	20	33.3	51.8	60.3	63.6	66.2	57.8	54.2	47.1	69.4
		50	34.1	51.6	60.7	62.7	66.1	57.2	54.0	47.0	69.1
		100	34.7	51.8	59.9	61.3	64.6	55.0	52.0	44.5	67.7
	Low	20	24.7	39.5	47.5	49.2	52.3	42.1	37.0	29.3	55.3
		50	27.3	41.7	50.4	51.8	54.3	44.5	39.3	30.9	57.7
		100	32.0	44.8	52.8	55.7	57.8	48.1	43.2	33.6	61.1
42HS010	High	20	35.7	52.6	60.9	64.0	67.5	59.3	57.9	51.5	70.5
		50	37.0	53.6	61.2	63.0	66.9	58.2	57.2	49.8	69.9
		100	35.1	52.2	60.4	62.6	65.7	57.4	55.4	47.3	68.9
	Medium	20	34.9	51.2	59.7	62.0	65.4	56.6	55.2	47.7	68.5
		50	35.1	52.0	59.5	61.2	65.4	56.6	55.3	47.4	68.2
		100	33.6	51.1	59.0	61.1	64.1	55.9	53.7	44.6	67.4
	Low	20	25.3	40.8	48.3	51.0	53.5	44.0	40.3	30.6	56.7
		50	26.6	43.0	50.1	52.8	54.8	45.8	41.4	31.1	58.3
		100	32.3	47.9	55.0	56.8	58.7	50.2	46.0	35.1	62.5
42HS012	High	20	35.4	56.3	62.5	64.9	66.9	60.3	58.9	52.8	70.9
		50	36.2	56.0	62.9	64.3	66.8	59.8	58.0	51.3	70.7
		100	35.7	56.3	62.0	63.5	66.6	59.1	56.7	49.3	70.1
	Medium	20	29.9	49.5	54.8	57.6	60.3	52.5	49.6	39.3	63.6
		50	31.8	50.0	55.5	58.3	60.4	53.3	50.1	40.0	64.1
		100	32.7	50.9	56.0	58.3	61.0	53.6	49.9	39.0	64.5
	Low	20	26.9	44.9	49.7	52.9	54.8	47.1	42.7	32.0	58.4
		50	27.9	45.4	50.2	53.8	56.0	47.9	43.0	32.1	59.4
		100	33.7	49.9	55.2	57.6	59.7	51.5	45.8	33.9	63.3
42HS014	High	20	37.6	59.6	64.8	66.0	67.8	63.1	60.4	44.1	72.4
		50	38.9	58.8	64.3	65.6	68.1	63.1	60.0	43.5	72.3
		100	38.6	58.2	63.8	64.0	67.3	61.2	58.6	41.4	71.2
	Medium	20	37.1	57.3	62.9	64.2	66.1	60.8	58.0	40.7	70.5
		50	37.4	57.2	62.5	64.0	66.4	60.7	58.2	40.7	70.5
		100	37.0	57.3	61.4	62.7	65.5	59.4	56.7	38.8	69.4
	Low	20	27.5	42.3	45.6	48.9	51.1	44.6	39.4	26.5	54.8
		50	27.9	43.0	47.0	49.8	52.1	45.3	39.7	26.4	55.8
		100	32.8	48.7	51.5	53.4	55.8	49.0	43.7	27.4	59.7
42HS016	High	20	38.5	59.4	64.2	68.3	67.4	62.5	61.7	56.4	72.9
		50	41.1	60.0	64.4	67.9	68.0	62.6	61.6	56.3	73.0
		100	39.8	60.0	63.9	67.3	67.3	61.7	60.4	54.1	72.4
	Medium	20	37.9	58.3	62.9	66.9	65.8	60.9	60.2	54.1	71.5
		50	39.5	58.3	62.4	66.4	66.1	60.8	60.4	54.3	71.3
		100	40.4	58.6	62.8	66.7	66.3	60.7	59.3	52.1	71.4
	Low	20	31.3	47.6	51.6	58.4	55.4	49.9	47.6	37.0	61.5
		50	32.7	49.1	53.5	58.7	56.7	50.5	47.8	37.2	62.3
		100	37.0	52.4	57.1	61.4	60.0	53.6	50.1	39.1	65.4
42HS018	High	20	41.8	60.8	65.7	67.4	67.6	63.7	62.7	57.2	73.2
		50	40.5	60.1	65.0	67.3	67.9	63.5	62.6	56.9	73.1
		100	40.8	59.5	65.7	66.8	67.1	62.8	61.5	55.0	72.6
	Medium	20	39.5	59.8	66.0	66.5	66.3	62.9	61.8	55.7	72.3
		50	39.9	58.5	63.7	66.4	66.4	62.4	61.4	54.7	71.9
		100	41.1	58.8	64.1	65.9	66.2	62.2	60.8	53.4	71.6
	Low	20	31.8	46.6	52.2	55.1	54.4	50.7	48.0	36.9	60.0
		50	34.2	48.1	52.6	55.7	54.5	50.7	47.9	36.2	60.3
		100	37.2	51.4	55.8	58.5	57.6	53.5	49.9	38.3	63.3
42HS020	High	20	42.3	60.9	66.9	69.0	68.2	64.5	63.0	58.3	74.2
		50	41.9	59.5	66.7	68.8	67.8	64.2	62.7	57.6	73.9
		100	42.2	59.2	65.7	67.7	67.3	63.7	62.0	56.1	73.0
	Medium	20	40.9	59.0	64.7	67.6	66.5	63.0	61.2	55.5	72.5
		50	41.1	59.2	64.9	67.7	66.8	63.2	61.4	55.8	72.7
		100	40.7	58.8	64.5	67.5	66.4	62.8	61.0	55.2	72.4
	Low	20	31.4	46.8	53.6	56.6	54.4	50.6	49.5	38.7	60.9
		50	33.6	47.7	54.3	57.2	55.1	51.4	48.9	38.4	61.5
		100	37.2	52.2	57.7	59.7	57.9	54.8	50.6	39.5	64.4

Wiring

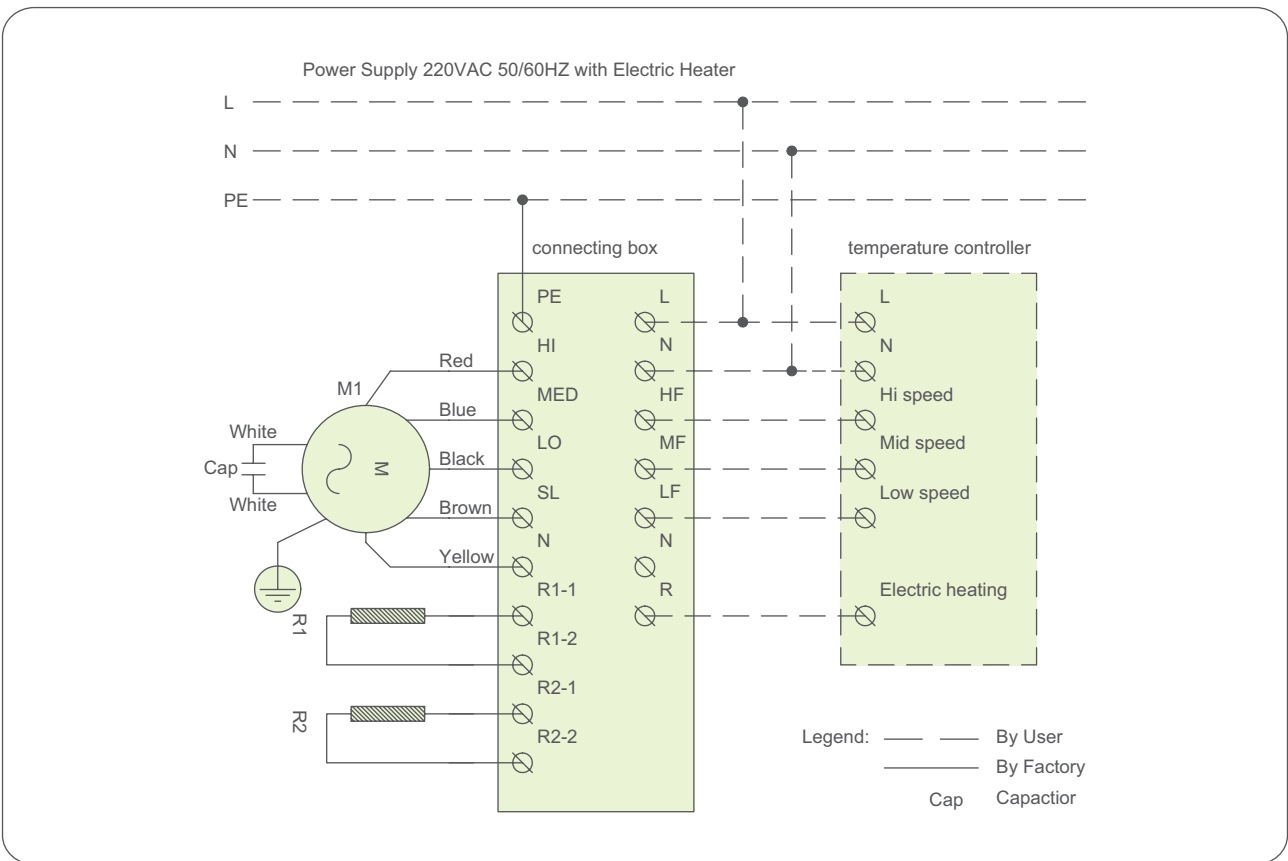
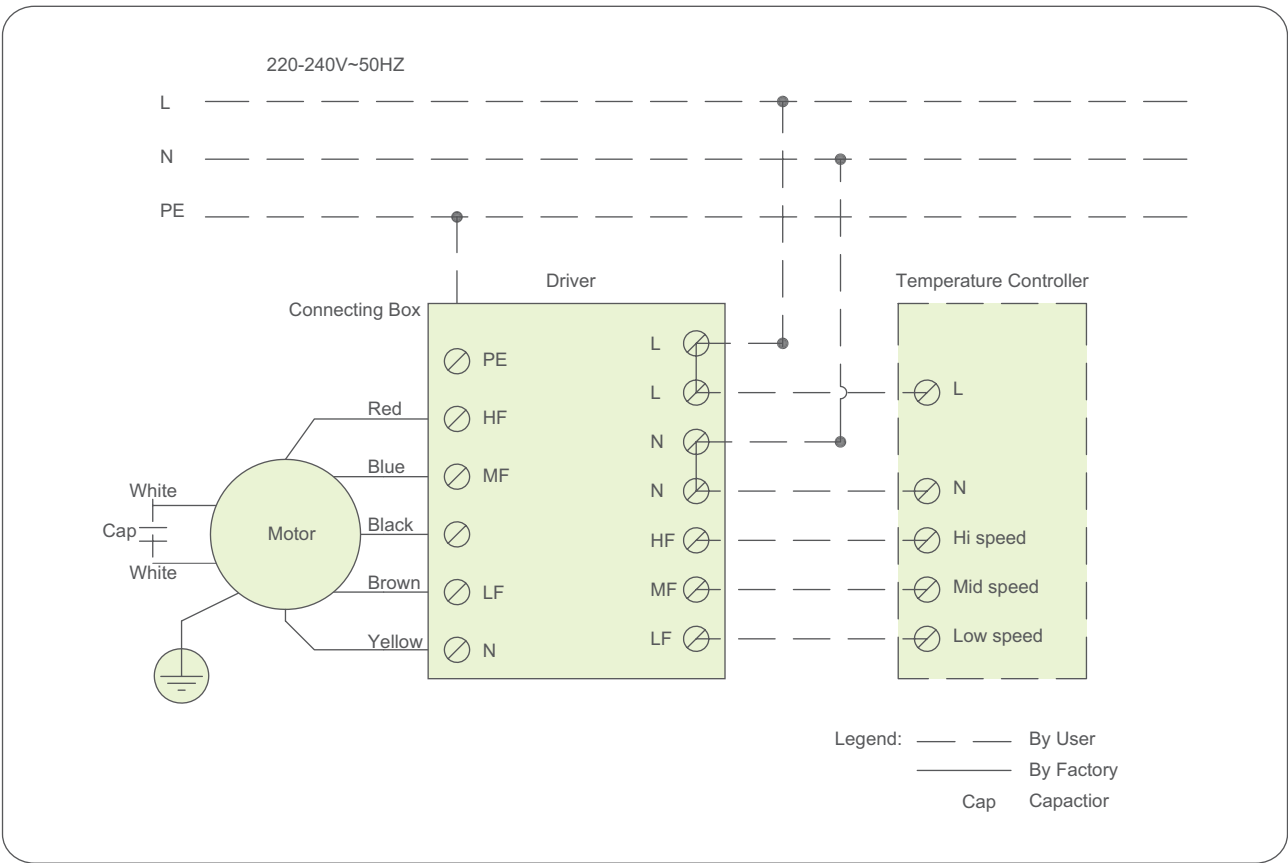

Electrical Data

Power Supply 230V-1Ph-50Hz

Model	Maximum Absorbed Power (W)	No. of Motors	F.L.A (A.M.P)	R.C.S (mm ²)	C.B (AMP)
42HS008	264	1	1.2	1.5	3
42HS010	330	1	1.5	1.5	3
42HS012	418	1	1.9	1.5	4
42HS014	528	1	2.4	1.5	6
42HS016	660	1	3.0	1.5	6
42HS018	704	1	3.2	1.5	6
42HS020	880	1	4.0	1.5	8

Power Supply 230V-1Ph-60Hz

Model	Maximum Absorbed Power W	No. of Motors	F.L.A(A.M.P)	R.C.S (mm ²)	C.B (AMP)
42HS008	339	1	1.8	1.5	4
42HS010	425	1	2.3	1.5	4
42HS012	580	1	3.2	1.5	6
42HS014	792	1	4.3	1.5	8
42HS016	526	1	2.9	1.5	6
42HS018	536	1	2.9	1.5	6
42HS020	815	1	4.4	1.5	8

Note: F.L.A: Full Load Ampere (For each Motor)

C.B: Circuit Breaker

R.C.S: Recommended Cable Size



Carrier improves the world around us; Carrier improves people's lives; our products and services improve building performance; our culture of improvement will not allow us to rest when it comes to the environment.



www.carrier.com

The Manufacturer reserves the right to change any product specifications without prior notices
©ALL Rights Reserved, Carrier® is a registered trademark of Carrier corporation.

Version:	CAT_42HS_E-1803_03
Supersede:	CAT_42HS_E-1605_02
Effective date:	Mar, 2018